

# BANDRASTER

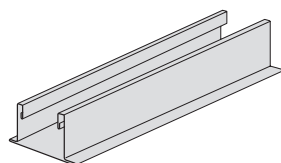

Bandraster is a suspension system available in a wide range of widths, compatible with Prelude 24 TLX/XL<sup>2</sup> Cross Tees.

## Bandraster Systems

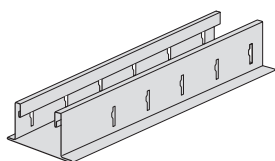
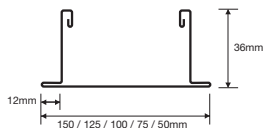

Item Nr.	Dimensions		Content / Carton		Weight / Carton kg	Cartons / Pallet
	length (mm)	Height (mm)	pcs	lm		

### Slotted at 312,50 mm (1)

BP 36 2100 B	3750	100	8	30,00	32,60	16
--------------	------	-----	---	-------	-------	----

### Slotted at 100 mm (1)

BP 36 3050	3600	50	8	28,80	24,00	28
BP 36 3075	3600	75	8	28,80	27,70	20
BP 36 3100*	3600	100	8	28,80	31,40	16
BP 36 3125	3600	125	8	28,80	38,30	12
BP 36 3150	3600	150	4	14,40	21,20	20

### Unslotted (2)

BP 36 0050 A	3600	50	8	28,80	24,00	28
BP 36 0075 A*	3600	75	8	28,80	27,70	20
BP 36 0100 A	3600	100	8	28,80	31,40	16
BP 36 0125 A	3600	125	8	28,80	38,30	12
BP 36 0150	3600	150	4	14,40	21,20	20

(1) Is compatible with all edge details, even including Orcal planks (SE, TE8, TE16, TE30) and SL2 planks, but the slots are not required for the Orcal and SL2 planks.

(2) Is only compatible with Orcal planks (SE, TE8, TE16, TE30) and SL2 planks (i.e. not Tegular or MicroLook planks).

## Bandraster Accessories

Item Nr.	Description	Dimension height (mm)	Content / Carton pcs	Weight / Carton kg
----------	-------------	-----------------------	----------------------	--------------------

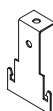

BPA 36 0501	Strip / rod connector	50	50	1,20
BPA 36 0751		75	50	1,50
BPA 36 1001		100	50	1,80

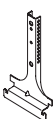

BPA 36 0502 G	Nonius hanger	50	100	5,80
BPA 36 0752 G		75	100	8,10
BPA 36 1002 G		100	100	11,00
BPA 36 1252 G		125	100	12,50
BPA 36 1502 G		150	100	15,00

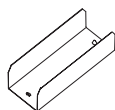

BPA 36 0503 G	Splice	50	100	8,00
BPA 36 0753 G		75	100	8,30
BPA 36 1003 G		100	100	14,00
BPA 36 1253 G		125	100	17,00
BPA 36 1503 G		150	100	19,50

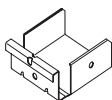

BPA 36 0504 G	Cross connector	50	100	5,80
BPA 36 0754 G		75	100	8,10
BPA 36 1004 G		100	100	11,00
BPA 36 1254 G		125	100	12,50
BPA 36 1504 G		150	50	7,50

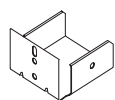

BPA 36 0505 G	Wall connector	50	100	5,80
BPA 36 0755 G		75	100	8,10
BPA 36 1005 G		100	100	11,00
BPA 36 1255 G		125	100	12,50
BPA 36 1505 G		150	50	7,50

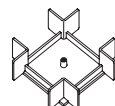

BPA 36 0506 G	Crossing element	50	48	7,70
BPA 36 0756 G		75	30	5,70
BPA 36 1006 G		100	32	7,40

\*Also available in RAL 9010 (WR)

All measurements in millimetres. All sizes are nominal.

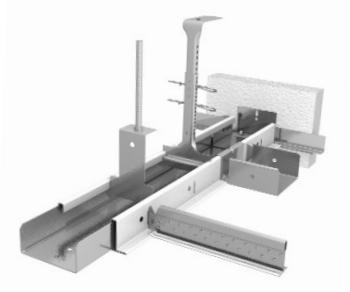

# BANDRASTER

## System Drawing

- Slotted Bandraster is compatible either with Prelude 24 XL<sup>2</sup> or Prelude 24 TLX Cross Tees
- On special request: Prelude 15 TL can be made compatible for installation with slotted Bandraster;
- Special spaced slotting; minimum slot spacing is 50 mm; Maximum length of Bandraster is 6000 mm

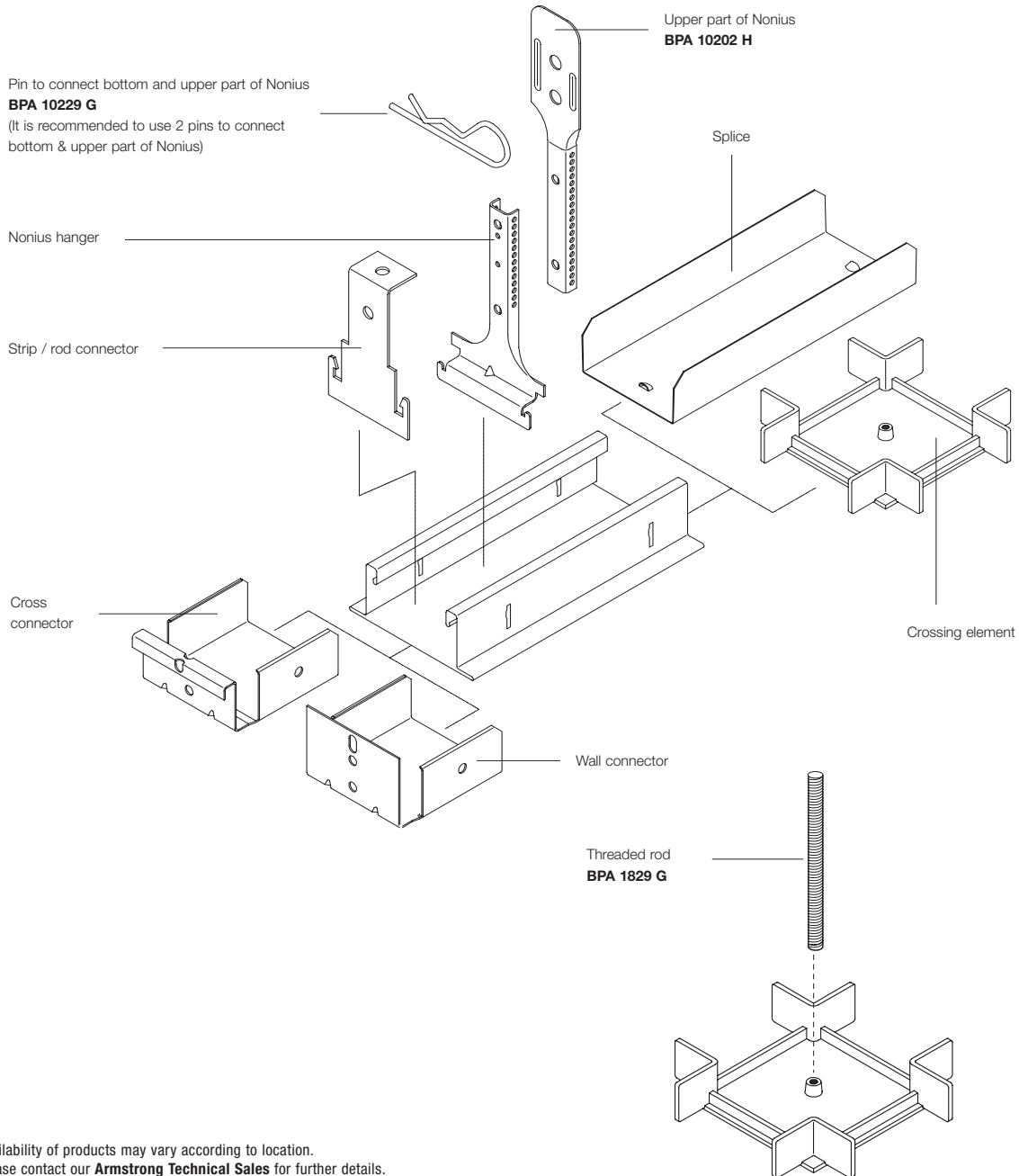

Availability of products may vary according to location.  
Please contact our **Armstrong Technical Sales** for further details.

**UNITED KINGDOM / REPUBLIC OF IRELAND**

**Armstrong World Industries Ltd.**

Building Products Division  
Armstrong House  
38 Market Square  
Uxbridge UB8 1NG

Tel : **0800 371849 (UK)** **FREEPHONE**

**1800 409002 (ROI)**

Fax : +44 (0) 1895 274287

e-mail : sales-support@armstrong.com

[www.armstrong-ceilings.co.uk](http://www.armstrong-ceilings.co.uk)

[www.armstrong-ceilings.ie](http://www.armstrong-ceilings.ie)

[www.armstrong.eu](http://www.armstrong.eu)

